



**Second South East European
Regional CIGRE Conference**

SEERC

Kyiv, Ukraine, 12-13 June 2018

Paper number 93

**Implementation of Sweep Frequency Response
Analysis (SFRA) for Condition Assessment of Power
and Distribution Transformers**

Mahmut Erkut Cebeci
EPRA, Turkey

Contents

- Transformers in electrical network
- Common transformer failures
- Sweep Frequency Response Analysis (SFRA)
- SFRA technique and methods
 - Connection of the SFRA device
 - Reference fingerprint
 - SFRA measurement type
 - Comparative tests
- Assessment of the SFRA test results

Transformers in electrical networks

- Power Transformer



- Distribution Transformer

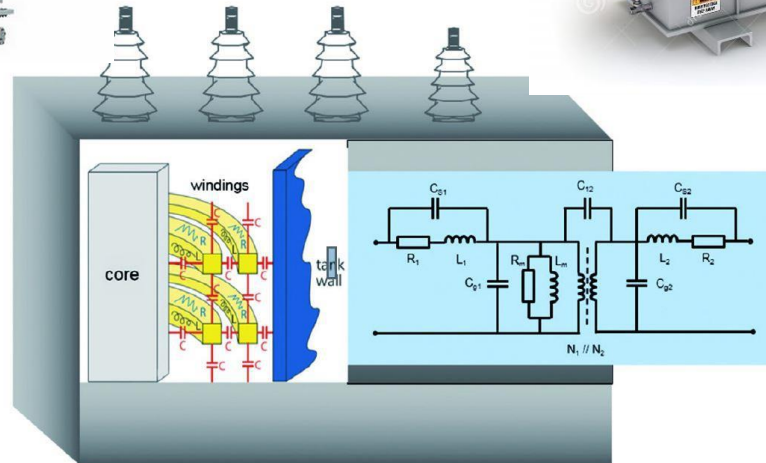

Transformer common failures

- Transformer winding deformation
- Inter turn short circuit
- Broken conductor in winding
- Broken clamping elements

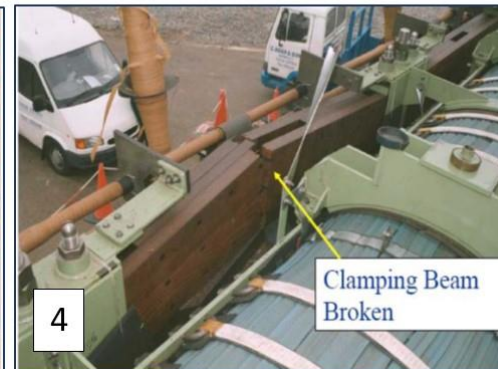

Sweep Frequency Response Analysis (SFRA)

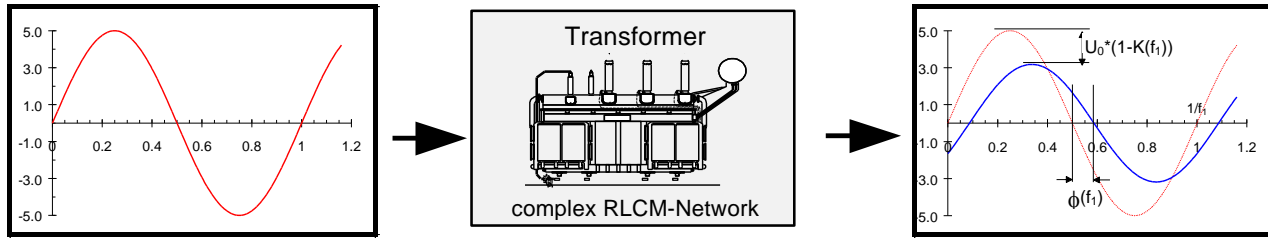

sine generator
(variable frequency)

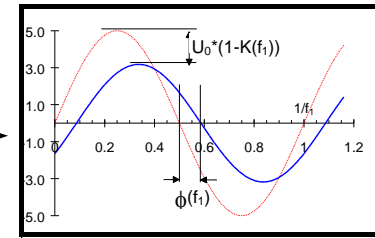
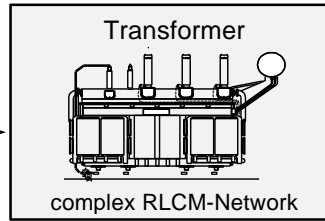

$K(f_1)$

$\phi(f_1)$

Magnitude

Phase

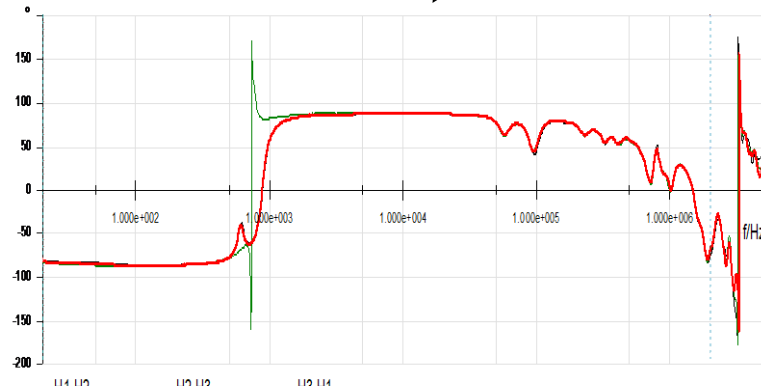
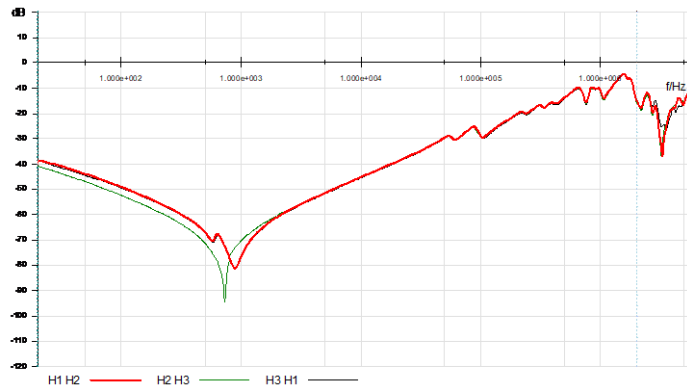

$$H(dB) = 20 \log_{10} \left(\frac{V_{out}}{V_{in}} \right)$$

SFRA technique and methods

- Connection of the SFRA device

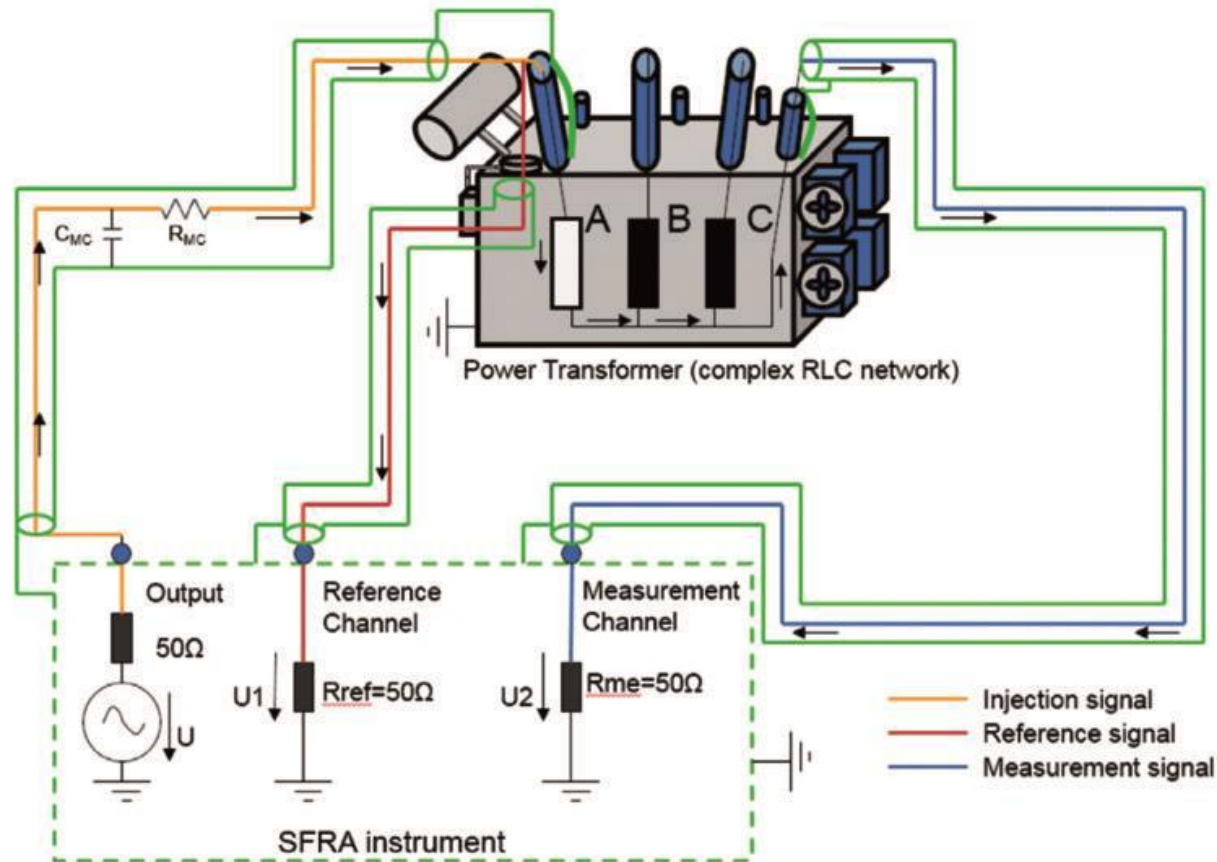

- Reference fingerprint

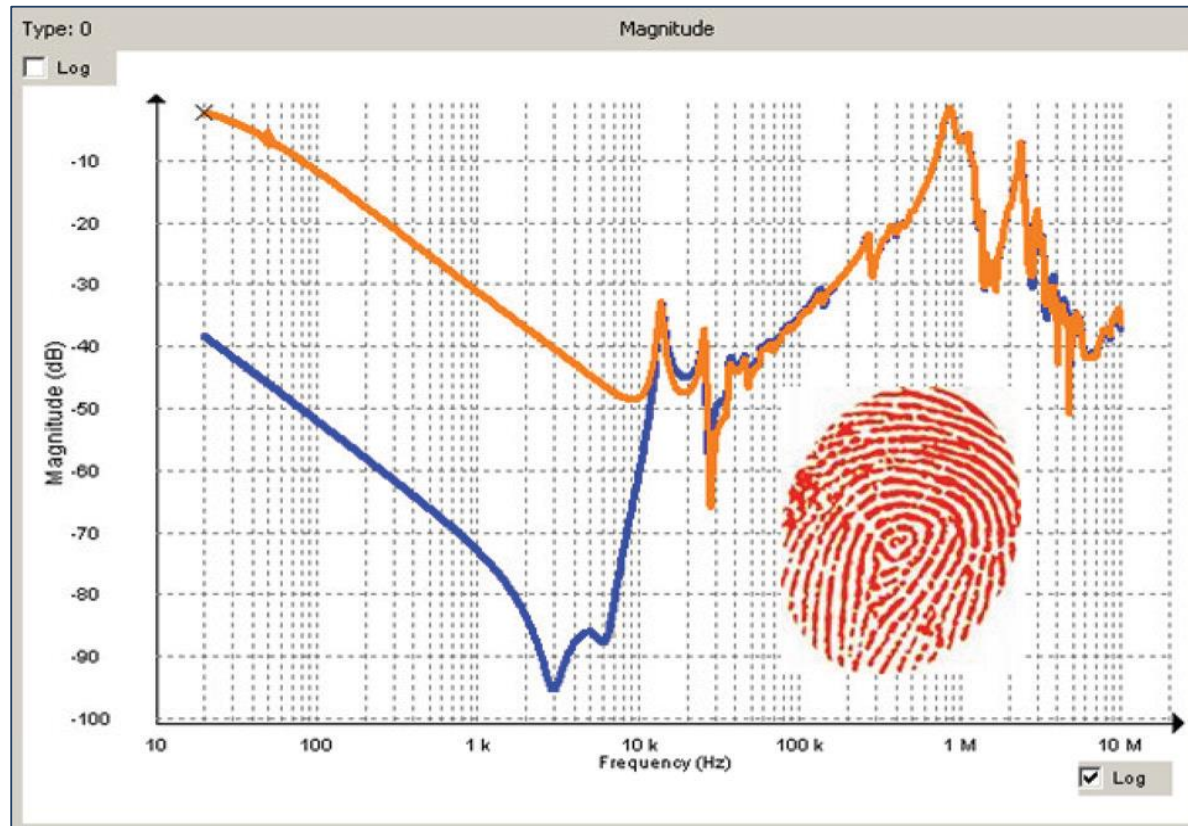

- SFRA measurement types

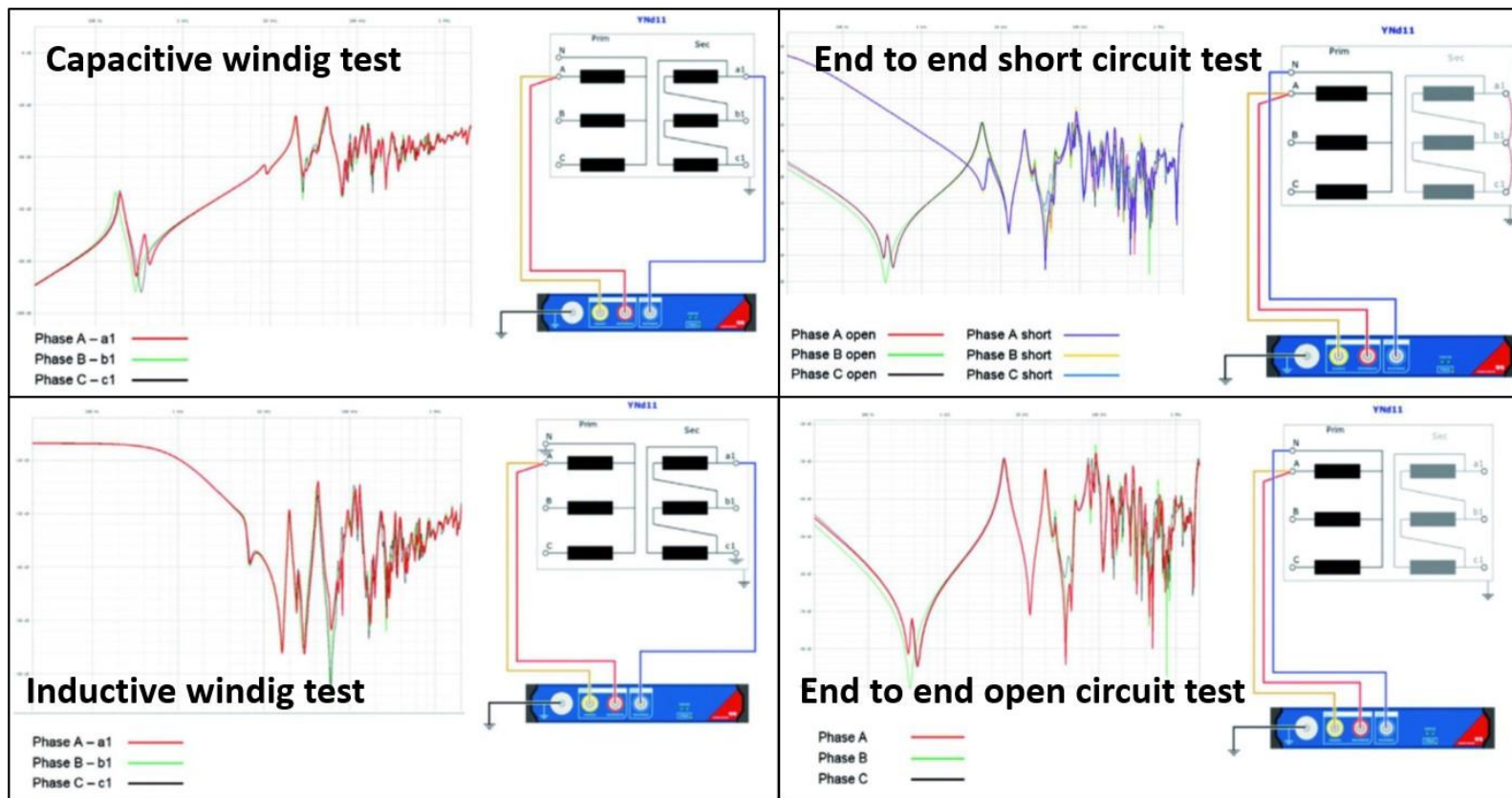

- Comparative tests

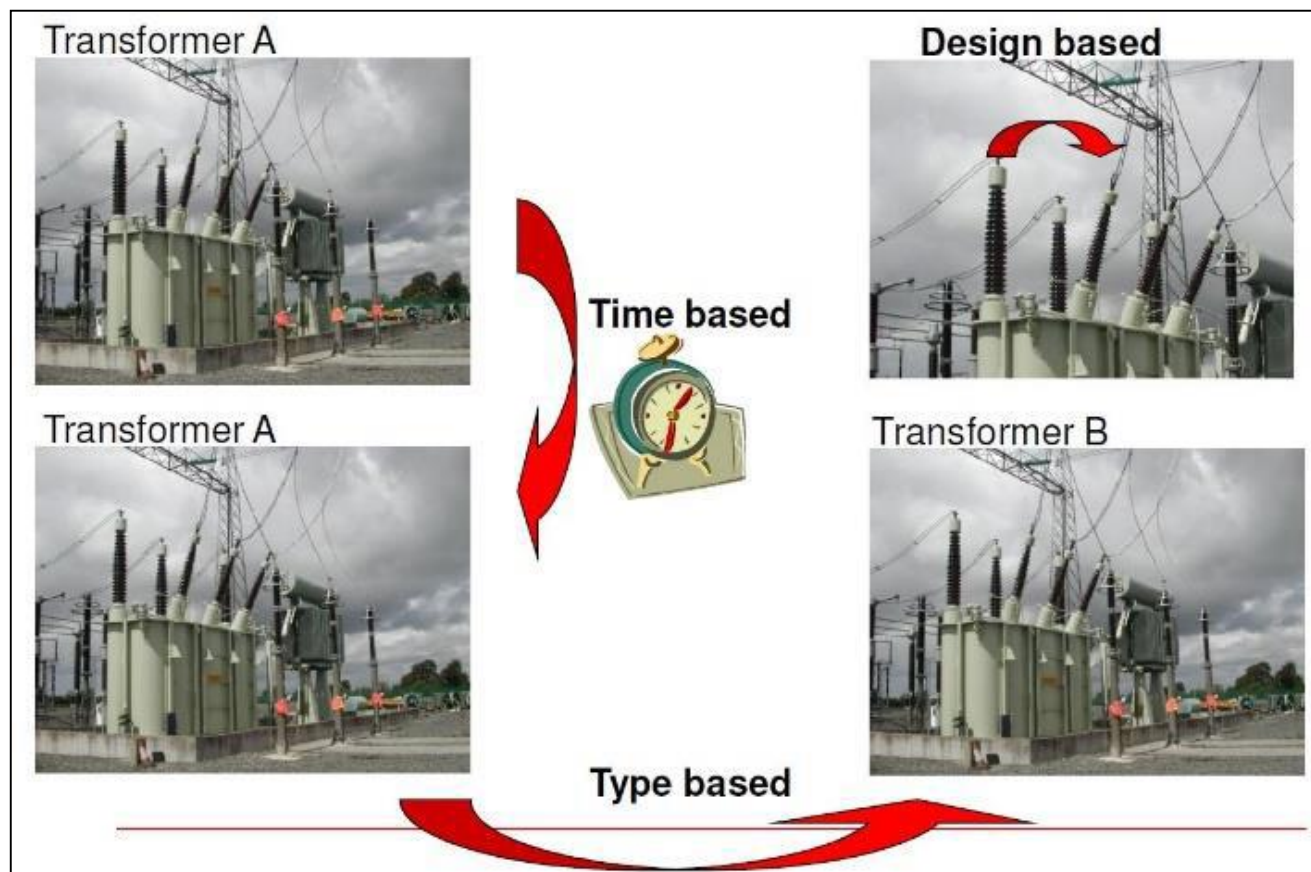

Assessment of the SFRA test results

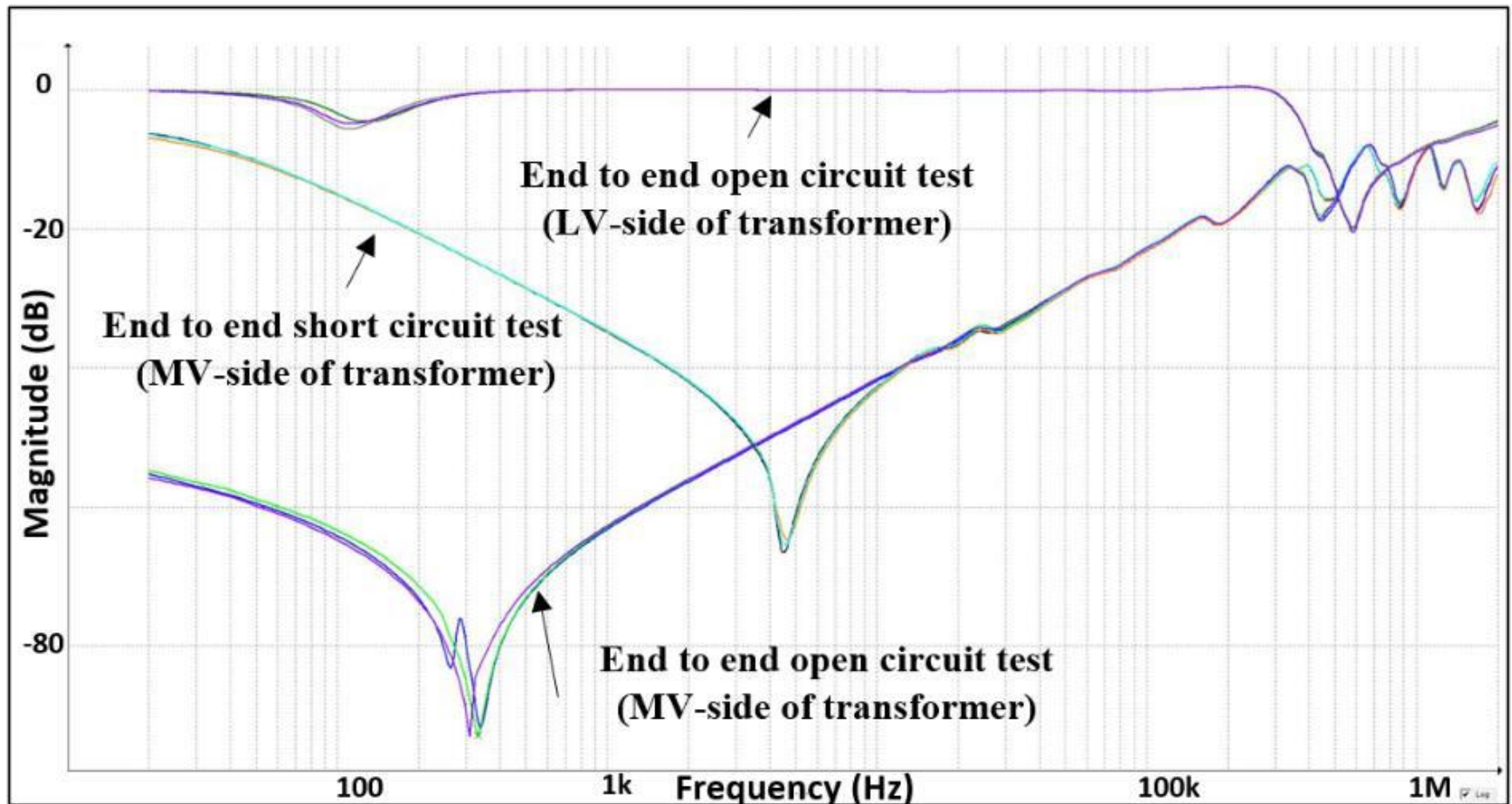

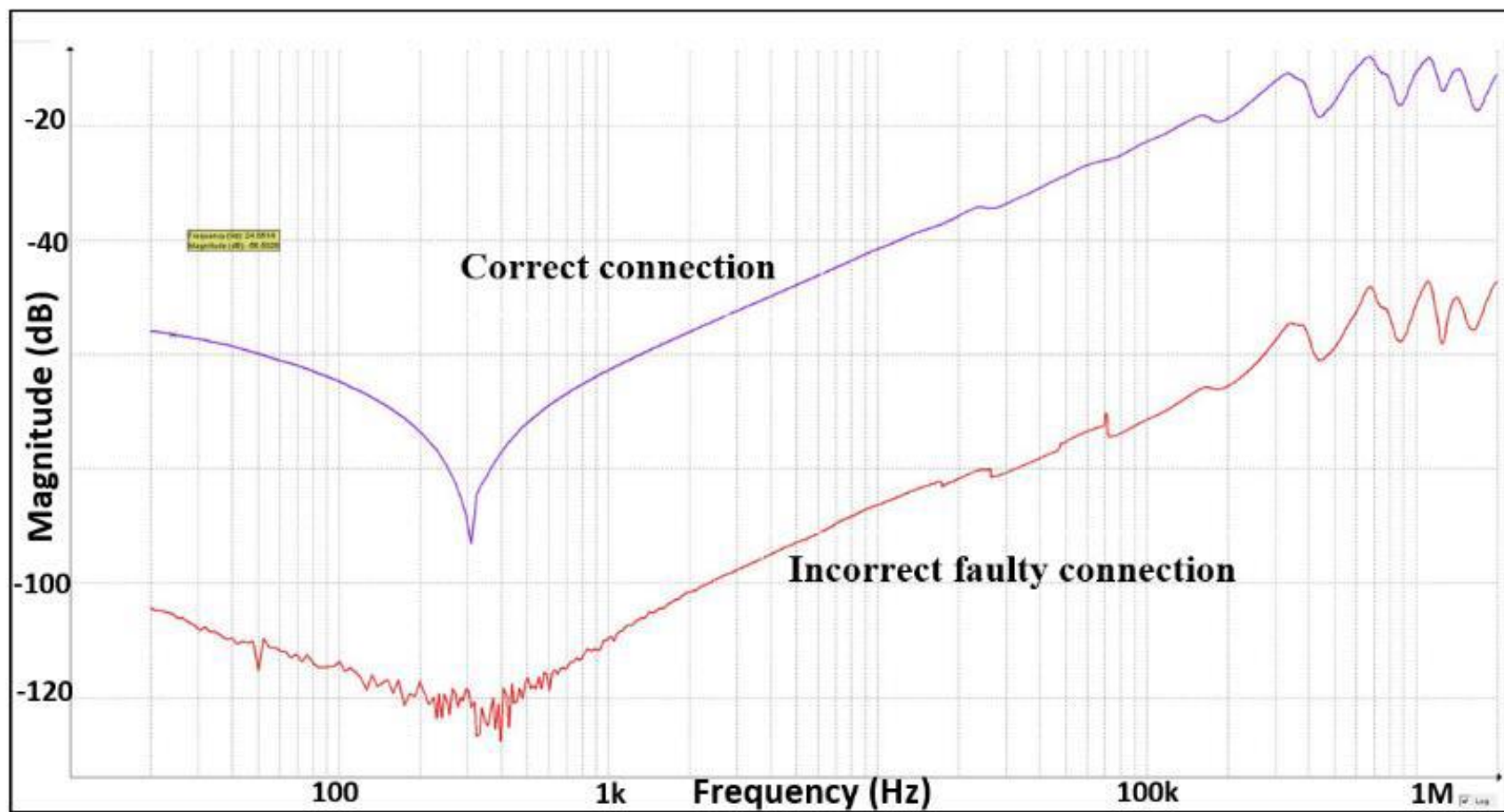

- Short and Open circuit tests in SFRA faulty transformer

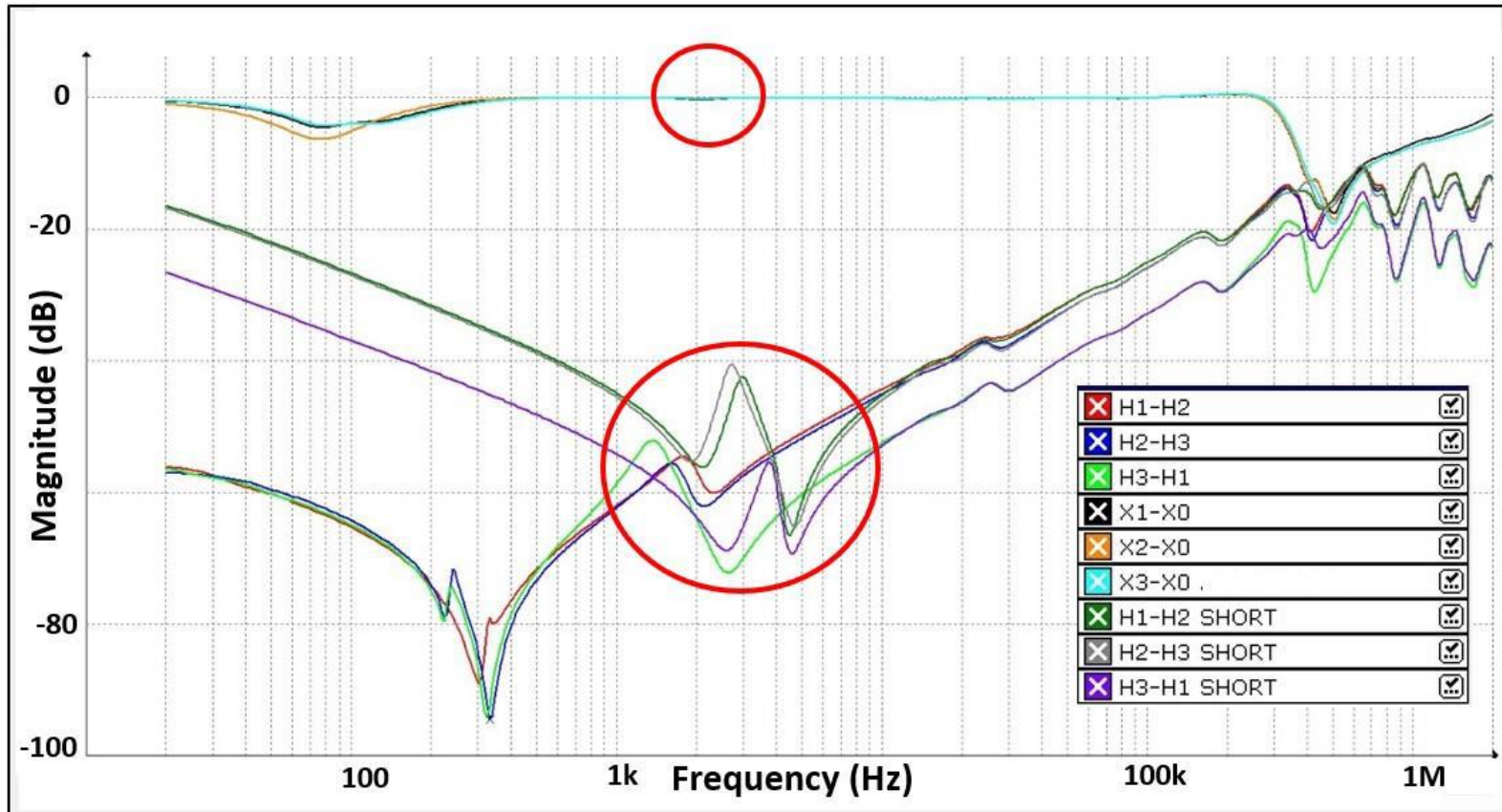

- Comparison of MV "C" phases with correlation Analysis

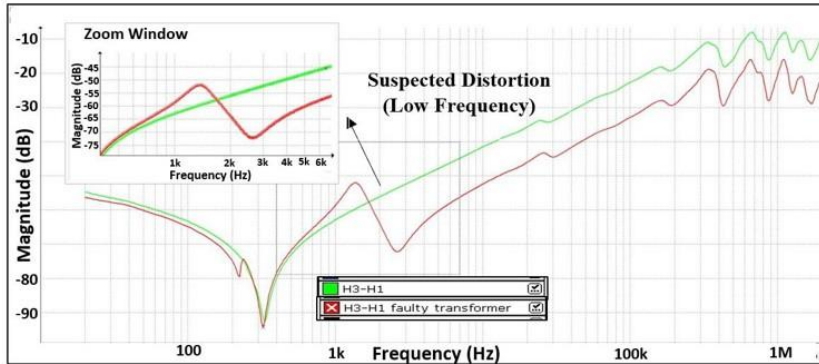

- Comparison of MV "C" phases with DL/T 911 analyzer

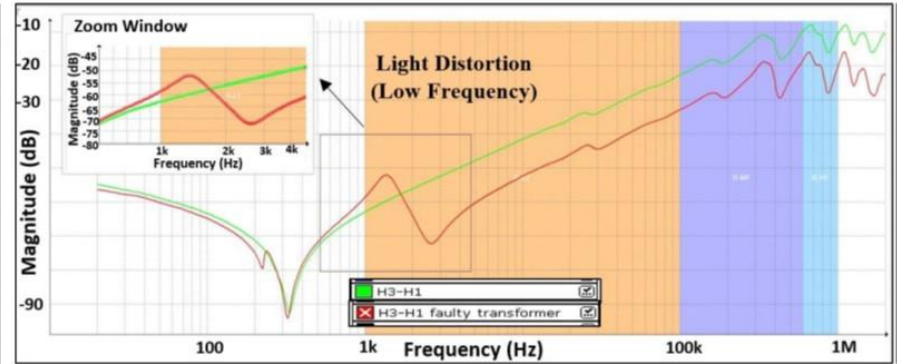

- Comparison of MV "c" phases with correlation Analysis

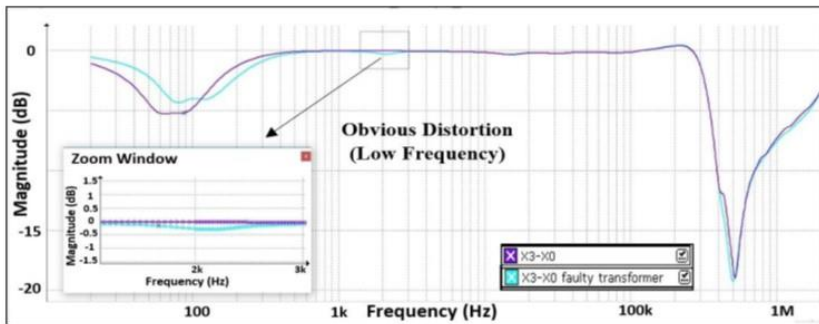

- Comparison of MV "c" phases with DL/T 911 analyzer

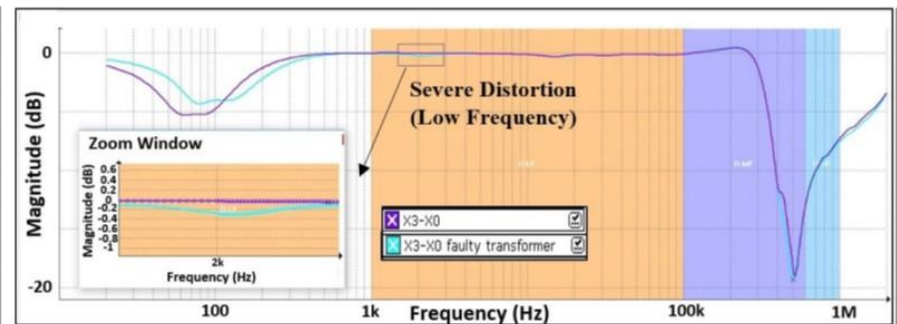

Thank you!

